

SIYANA PETROVA

Grasshopper Assignment 02

01 .
DEFINITION .

Pattern tiles 1

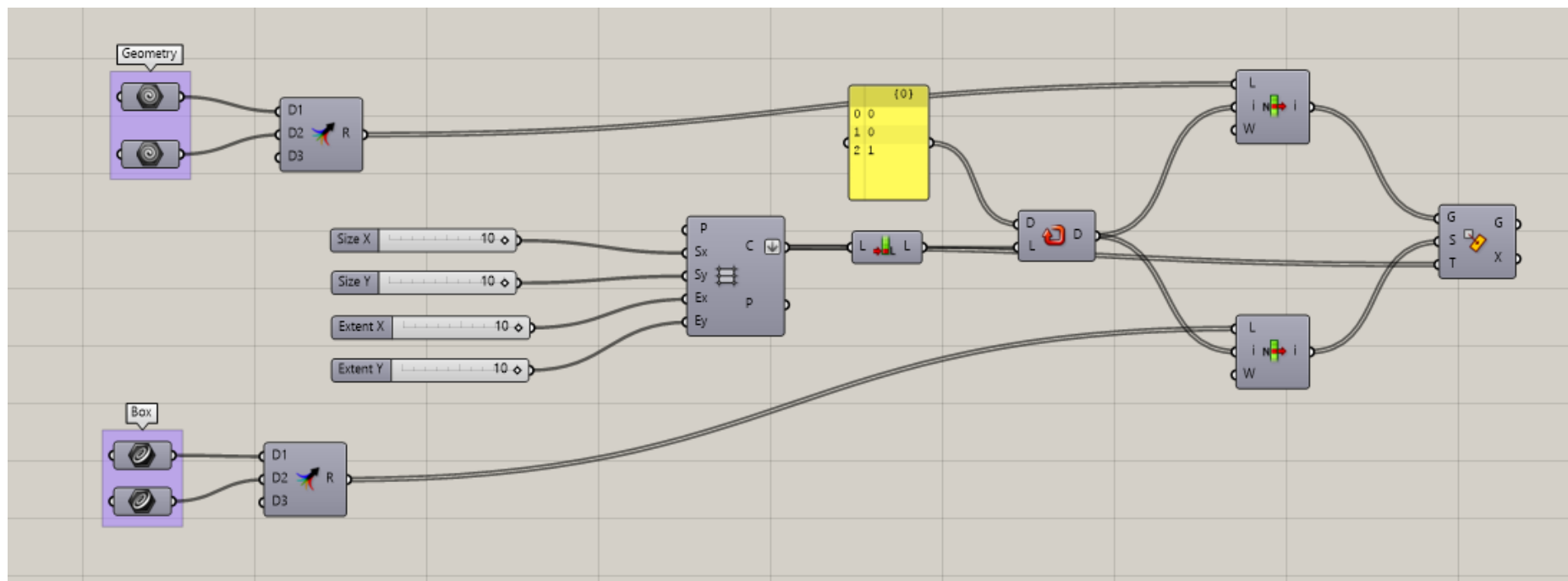
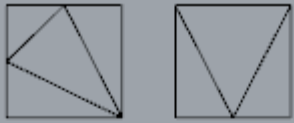

Pattern tiles 2

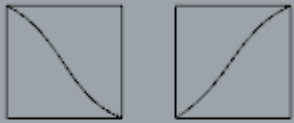

Pattern tiles 3



Pattern tiles 4



Pattern tiles 5

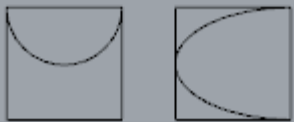

PATTERN TILES .

RESULTING PATTERNS .

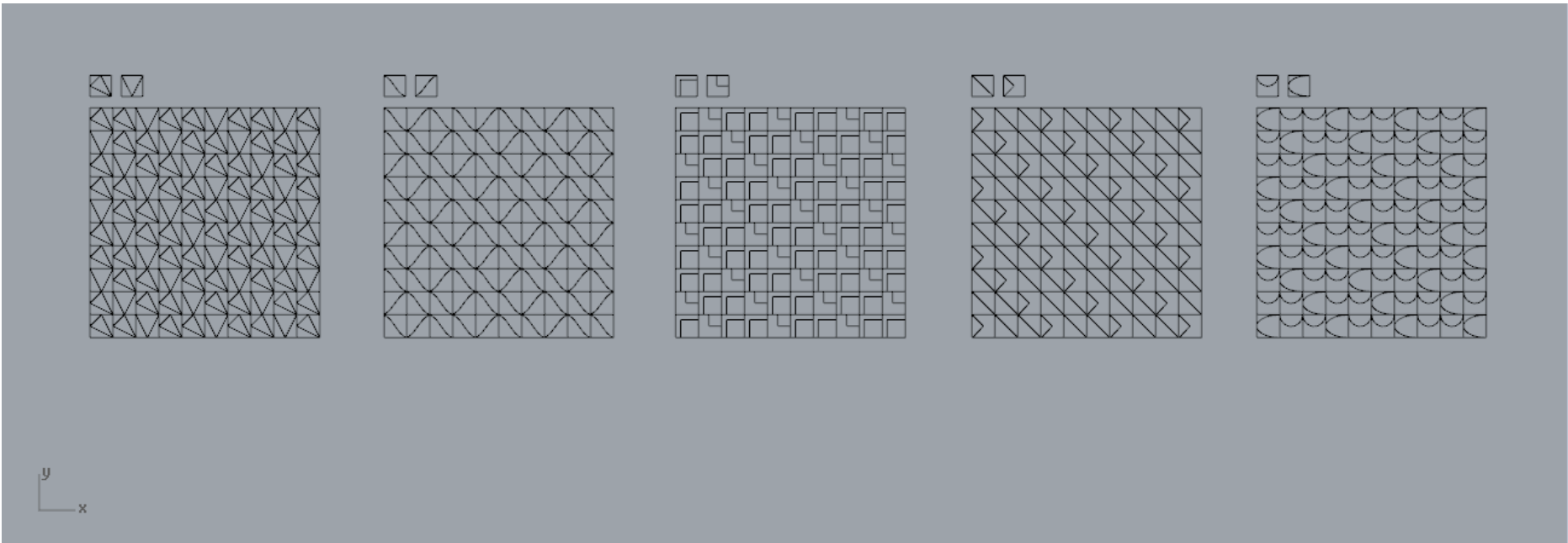

02 .
DEFINITION .

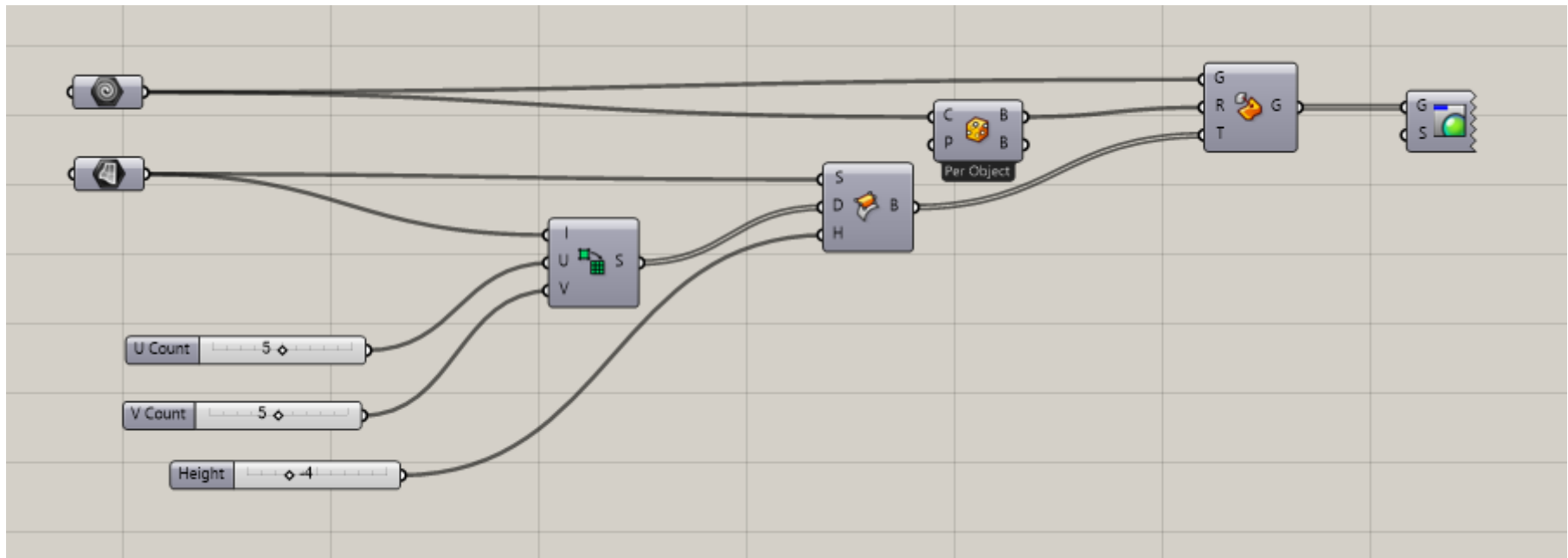

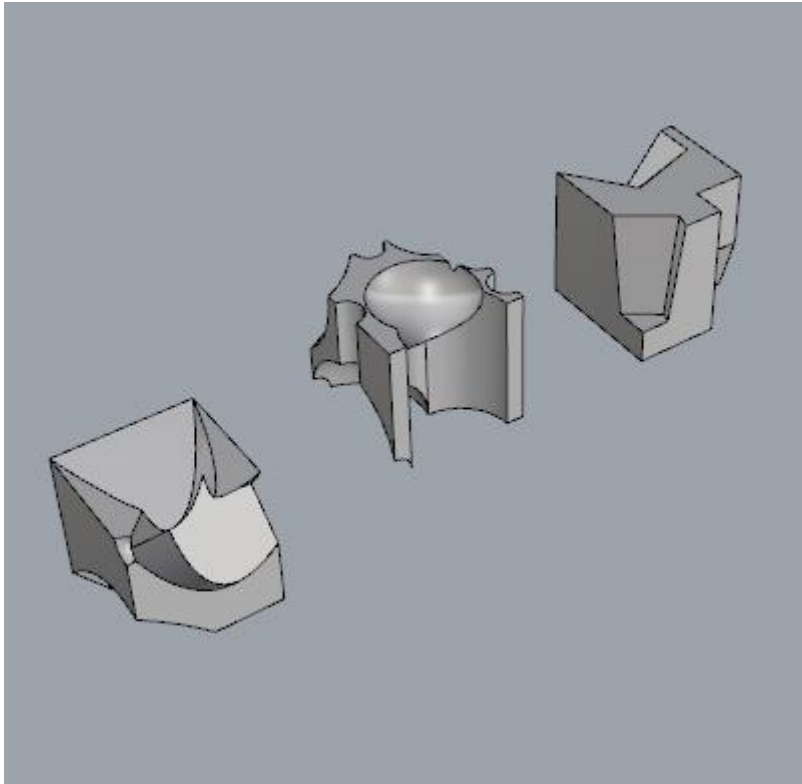

SURFACE MODULES .

RESULTING SURFACES .

